

12/8/2011

**Pulse Start Metal Halide  
320 Watt ED28 (Clear) Lamp**

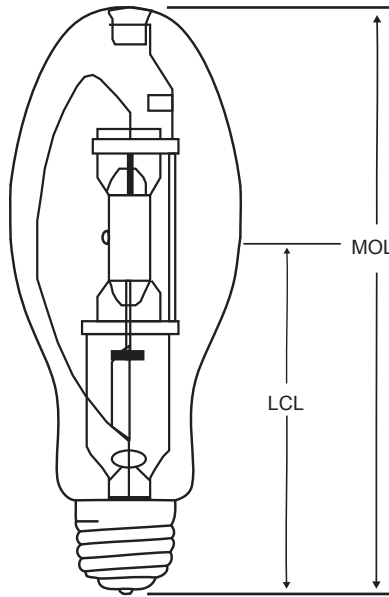

Project:	
Catalog#:	
Approved by:	

Ordering Information	
Howard Catalog Number (Ordering Code)	MH320/BU/ED28/PS
UPC Code	02693
ANSI Designation	M132/E
Description	Pulse Start Metal Halide
Package Quantity	12
Physical Characteristics	
Bulb Size	ED28
Bulb Finish	Clear
Base	Mogul
MOL (Maximum Overall Length) (in.)	8.31
LCL (Light Center Length) (in.)	5
DIA (Bulb Diameter)	4.09
Operating Characteristics	
Lamp Watts (Nominal)	320
Approx. Initial Lumens	34,000
Approx. Mean Lumens	27,200
Average Rated Life (Hours)	15,000
Color Temperature (K)	4200
CRI (Color Rendering Index)	70
Operating Position	
Base Up	

**Note:**

- WARNING: THIS LAMP CAN CAUSE SERIOUS SKIN AND EYE INFLAMMATION FROM SHORT WAVE ULTRAVIOLET RADIATION IF THE OUTER ENVELOPE OF THE LAMP IS BROKEN OR PUNCTURED. DO NOT USE WHERE PEOPLE WILL REMAIN FOR MORE THAN A FEW MINUTES UNLESS ADEQUATE SHIELDING OR OTHER SAFETY PRECAUTIONS ARE USED.** Lamps that will automatically extinguish when the outer envelope is broken or punctured are commercially available.
- Lamps with two (2) ANSI codes, the first is the new ANSI code and the second is the original.
- When operated on ballasts having a sustaining voltage less than 270V, lamp life may be significantly reduced.
- Lamps classified as E-type are to only be used in suitably enclosed luminaires. Please see Howard HID Lamp Warning.
- Electrical Shock and Burn Hazard: Do not remove or insert lamp when power is own. If outer glass bulb is broken, shut off power immediately and remove lamp after it has cooled.
- Protect lamp from direct contact with liquids to avoid breakage from thermal shock.
- This lamp must be used only with proper circuit and auxiliary equipment and suitable ballast.
- Do not scratch the glass of bulb or subject this lamp to undue pressure as either may cause lamp to break. Replace scratched, cracked, broken or damaged bulbs immediately.
- The lamp should be screwed firmly, but not forcibly, into the socket to reduce the possibility of loosening due to vibration. Use of excessive force may result in lamp breakage.
- Do not touch hot lamps with fingers, skin or any flammable material. Lamps may remain hot after being turned off.
- Keep combustible materials away from lamp during operation.
- Do not paint the lamp to prevent its overheating or breakage.
- This is a discharge lamp and requires some time to restart and come up to full brightness after a power interruption. Lamps may require 2 to 4 minutes to relight.
- Recycle lamps in accord with local, state, and federal disposal laws. See: [www.lamprecycle.org](http://www.lamprecycle.org).
- Specifications subject to change. Actual results may vary.

Pulse Start Metal Halide Lamps