

12/14/2011

**Compact Fluorescent Lamp - Plug-in
5 Watt Single Tube (2-Pin)**

Compact Fluorescent Lamps

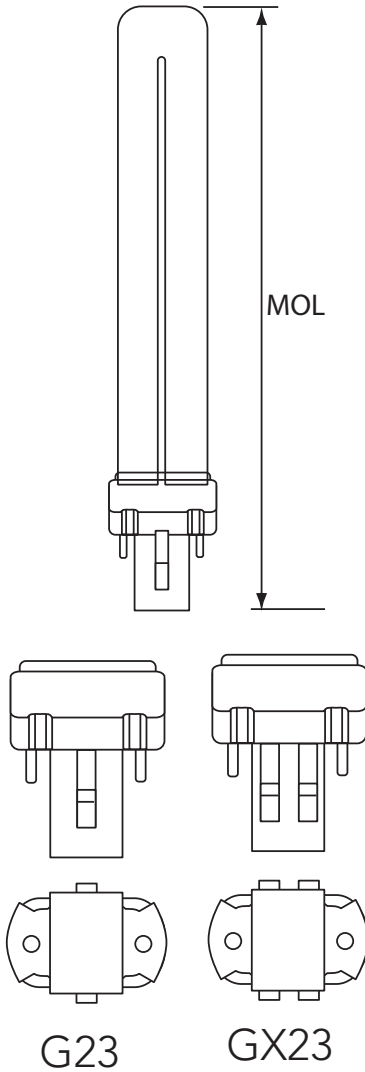

Project:	
Catalog#:	
Approved by:	

Ordering Information

Howard Catalog Number (Ordering Code)	CF5S/841
UPC Code	01359
Description	Compact Fluorescent
Package Quantity	50
Physical Characteristics	
Bulb	Single Tube
Base	G23
MOL (Maximum Overall Length)	110

Operating Characteristics

Lamp Watts (Nominal)	5
Approx. Initial Lumens	250
Approx. Mean Lumens	230
Average Rated Life (Hours)	10000
Color Temperature (K)	4100
CRI (Color Rendering Index)	82

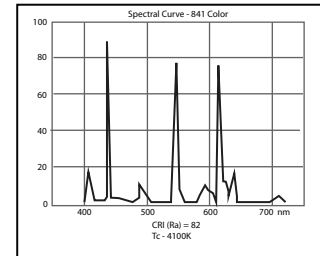
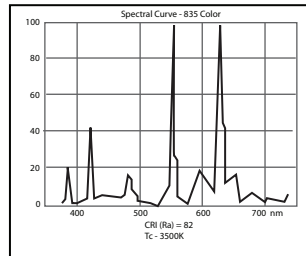
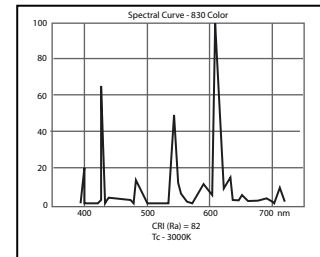
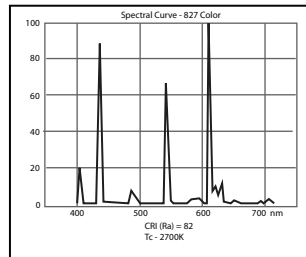

Note:

1. If the outer glass is broken, shut off the power immediately and remove the lamp after it has cooled.
2. Use within voltage limits recommended by ballast manufacturer.
3. Protect lamp base, socket and wiring against moisture, corrosive atmospheres and excessive heat.
4. Replace the lamp if the outer glass bulb has been scratched, cracked or damaged in any way.
6. Take care in handling and disposing of lamps.
7. Although this product meets TCLP, please dispose in accordance with federal, state and local requirements.

8. WARNINGS, CAUTIONS and OPERATING INSTRUCTIONS for

- Compact Fluorescent Lamps:** These lamps must be operated in fixtures designed for use with Compact Fluorescent Plug-in. The fixture wattage (rating) must match the wattage indicated on the outer glass bulb. Do not scratch the outer bulb or subject it to pressure as this could cause the outer bulb to crack or shatter. Operating the lamp improperly may result in **PERSONAL INJURY, PROPERTY DAMAGE, BURNS and FIRE.**
9. Specifications subject to change. Actual results may vary.