

# Installation Instructions

When using this lighting device, basic safety precautions should always be followed, including the following:

## READ AND FOLLOW ALL SAFETY INSTRUCTIONS

1. Prior to installation, battery connector must be open to prevent high voltage from being present on the output leads (red & yellow). It must be connected only after installation is complete and AC power is supplied to the unit.
2. This device is designed for use with one 2' to 4' 8W-28W T5/T5HO, 17W-40W T8, T12 linear lamp and 4-pin compact fluorescent lamps from 13W-50W. Contact manufacturer for more information about lamp compatibility.
3. Please ensure the electricity connections conform to the National Electrical Code and local regulations if applicable.
4. To avoid electrical shock, please disconnect normal and emergency power supplies, and battery connector of the emergency ballast before servicing.
5. This device is designed for factory or field installation in either the ballast channel or on top of the fixture, except air handling heated air outlets, sealed and gasketed fixtures, wet or hazardous location fixtures. Do not install this device near gas or electric heaters.
6. AC Power source of 120 VAC or 277 VAC is required.
7. The battery is sealed, no-maintenance, and is not replaceable in the field. Please contact manufacturer for information on service. Do not attempt to service the battery.
8. Do not use accessory equipment that is not recommended by manufacturer. Failure to do so may cause unsafe conditions. Servicing should only be performed by qualified service personnel.
9. Do not use this product for anything other than it's intended purpose.

Specifications subject to change without notice.

# Installation Instructions

Caution – Before installing, turn off the main circuit breaker to avoid any possible shock. Also make sure that the inverter connector is disconnected.

Emergency Ballast

- Mounting the Emergency Ballast:** Remove the ballast channel cover. Mount the Emergency Ballast in the ballast channel at least 1/2" away from the A.C. ballast(s). When battery packs are remote mounted, the remote distance can not exceed 1/2 of the distance from ballast to lamp specified by the AC ballast manufacturer. For example, if the AC ballast manufacturer recommends no more than 25' remote distance, then the battery pack should not exceed 12 1/2'. Under no circumstances should the battery pack exceed a distance of 50' from the lamp.
- Wiring:** Refer to the wiring diagrams page for the appropriate wiring of lamp(s) and ballast. Install in accordance with the National Electrical Code and local regulations. For additional wiring diagrams consult Customer Service.
- Installing the LED COMBO TEST SWITCH (LCTS):**

**Linear Fixture** – Select a convenient location on the fixture so that the LCTS can be seen after installation. Allow for proper clearance inside the fixture and drill or punch a 1/2" hole. Remove the nut from the LCTS. Push the LCTS housing into the 1/2" hole and secure with the nut. Connect the wires from the LCTS (VIOLET to VIOLET, BROWN to BROWN). Refer to figure 1.

**Recessed Troffer Fixture** – Select a convenient location with proper clearance in the ballast cover and drill or punch a 7/8" bushing into the hole. Push the plastic tube through the bushing. Route the leads of the LED COMBO SWITCH through the plastic tube. Connect the LED wires from the unit to the switch (Red to Red, White/Red to White). Push the entire assembly back into the tube until the lens collar rests against the plastic tube. The plastic tube should be adjusted so that the LED COMBO SWITCH is within 1/4" of the fixture lens. The switch must be visible after installation. Refer to figure 2.

Figure 1

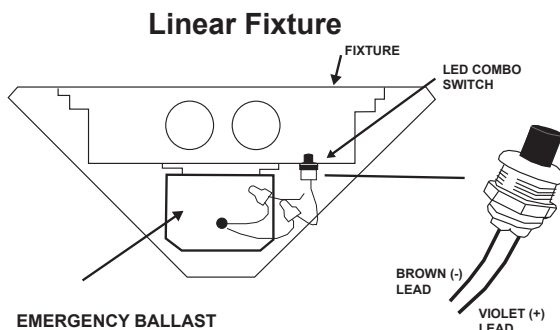

OBSERVE PROPER POLARITY

Figure 2

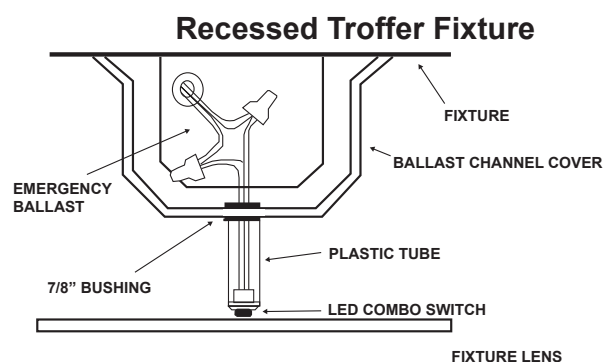

- Power Supply:** The Emergency Ballast and AC ballast must be on the same branch circuit. It requires an unswitched AC power source of either 120 or 277 volts. Select the proper voltage lead and cap the unused lead. When the Emergency Ballasts is used with a switched fixture, the AC input to the emergency ballast must be connected ahead of the fixture switch. Refer to the figure below for switched and unswitched fixture wiring diagrams.

Figure 3  
Ballast Wiring Block Diagram

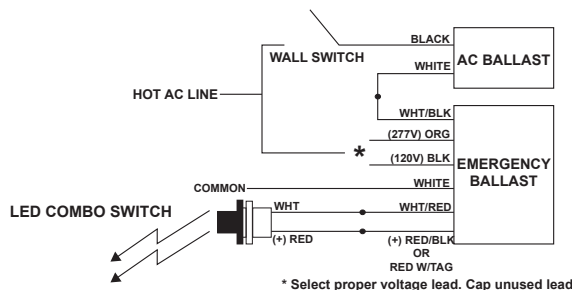

\* Select proper voltage lead. Cap unused lead

**SWITCHED FIXTURE**

Specifications subject to change without notice.

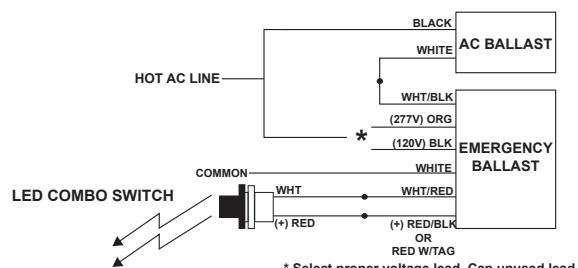

\* Select proper voltage lead. Cap unused lead

**UNSWITCHED FIXTURE**

# Installation Instructions

- 5. Labels:** Attach the appropriate labels adjacent to the LCTS. Annotate Re-Lamping label for lamp type and wattage. The 'Caution' and the Re-lamping labels must be on the fixture in a readily visible location to anyone attempting to service the fixture.
- 6. Completing Installation:** When Installation of the ballast is complete, switch the AC power on and join the emergency ballast's unit connector.

## OPERATION

**Normal Mode** – When AC power is present, the AC ballast operates the fluorescent lamp(s) as intended. The LCTS will be lit providing a visual indication that the emergency ballast is being charged.

**Emergency Mode** – When AC power fails, the LCTS senses the AC power failure and automatically switches to the Emergency mode. One lamp (or two depending on configuration and ballast) is illuminated, at reduced output, for a minimum of 90 minutes. When the AC power is restored, the Emergency Ballast switches the system back to the Normal Mode and resumes battery charging.

## TESTING AND MAINTENANCE

Pushing the red lens on the LCTS turns off the light on it, interrupts power to the designated AC ballast and forces the unit into emergency mode. The emergency lamp(s) is now being lit by the emergency ballast. On releasing the lens, fixture returns to normal mode after a momentary delay. To simulate a "BLACK OUT" use the circuit breaker to turn off AC power.

**Initial Testing** - Allow the unit to charge approximately 1 hour, and then press the LCTS to conduct a short discharge test. The ballast needs to be charged for at least 24 hours before conducting a 1-1/2 hour test.

This emergency ballast is a maintenance-free unit, however, periodic inspection and testing is required. NFPA 101, Life Safety Codes, outlines the following schedule:

**Monthly** – Insure that the LCTS is illuminated. Conduct a 30-second discharge test by depressing the LCTS. One lamp should operate at reduced output.

**Annually** - Insure that the LCTS is illuminated. Conduct a full 1-1/2 hour discharge test. The unit should operate as intended for the duration of the test.

"Written records of testing shall be kept by the owner for inspection by the authority having jurisdiction."

# Wiring Diagrams

Contact customer service for wiring diagrams not shown.

Emergency Ballast

## 1. One Lamp Rapid Start Ballast

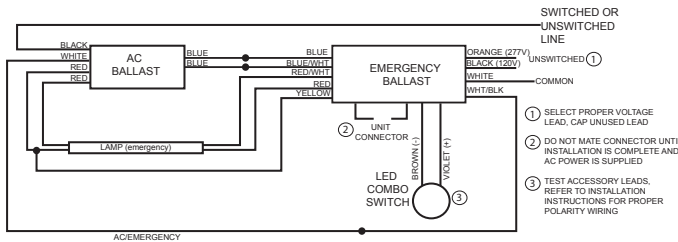

## 2. Two Lamp Rapid Start Ballast (TypeA)

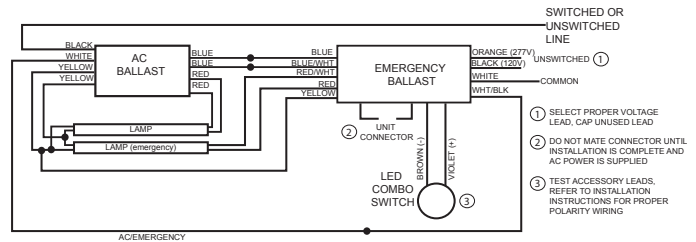

## 3. Two Lamp Rapid Start Ballast (TypeB)

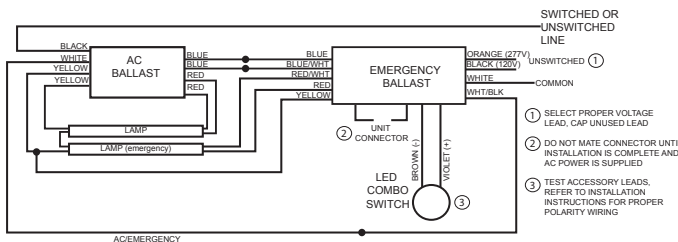

## 4. Three Lamp Rapid Start Ballast (TypeA)

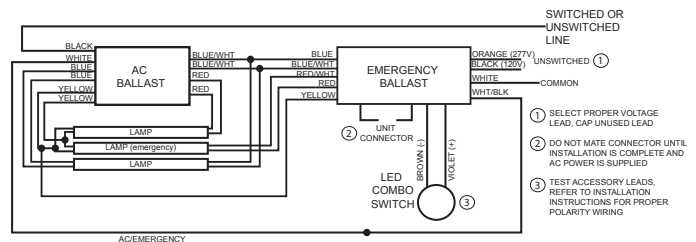

## 5. Three Lamp Rapid Start Ballast (TypeB)

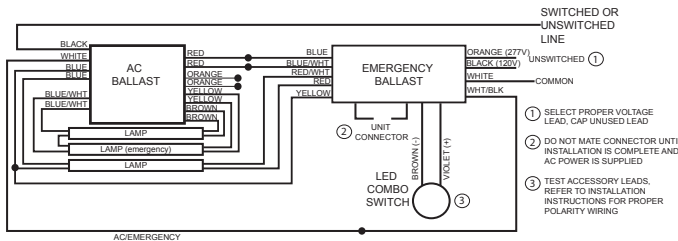

## 6. Four Lamp Rapid Start Ballast

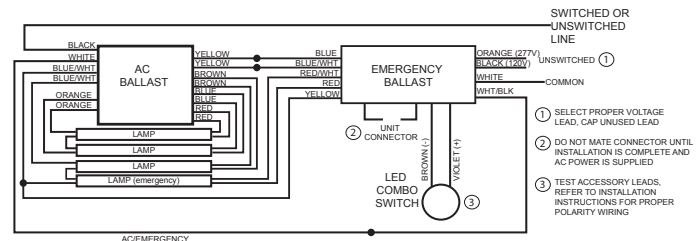

## 7. One Lamp Instant Start Ballast

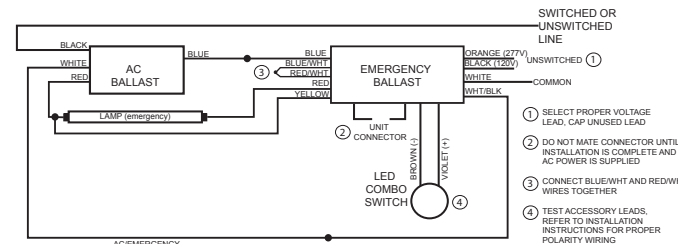

## 8. Two Lamp Instant Start Ballast

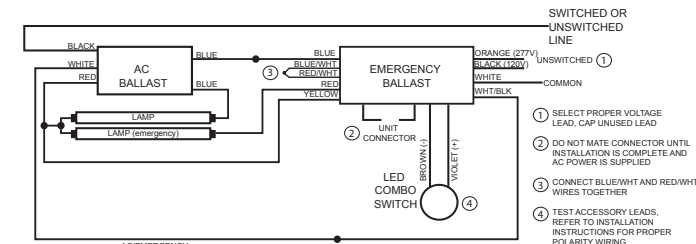

## 9. Three Lamp Instant Start Ballast

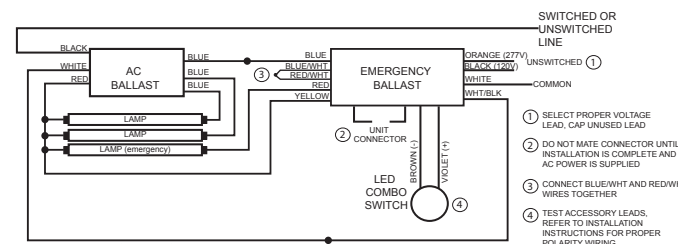

## 10. Four Lamp Instant Start Ballast

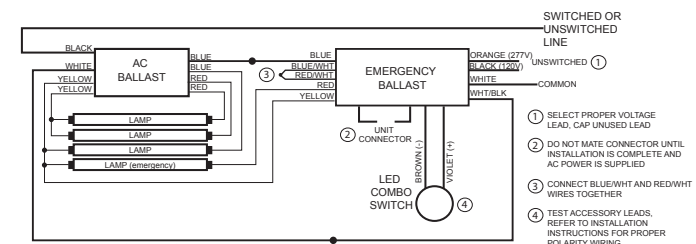

Specifications subject to change without notice.